

Digital Industrial Bowl Cutter / Chopper

K55s *Suprem*

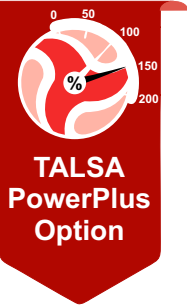

Market Leader in the Global Food Industry



New Suprem Bowl Cutter series: quality, innovation, performance.



Advantages at a glance

TALSA

- **Very high cutting speed**, fully variable from 500 up to 5000 rpm.
- German BE-Maschinenmesser knives, **special high resistance KUT steel**.
Minimum space between all knives and the bowl thanks to its large central diameter.
- **Slow mixing speed**, variable 50 to 500 rpm, **forward/reverse**.
- New vibration reduction technology at high revs, collaboration with the UPV Polytechnic University.
- **Simplified knife shaft**, very reliable, with advanced quality bearings and seals for high revs, 2 years guaranteed.
- **4 onscreen buttons for direct selection** of knife and bowl speeds, freely configurable.
- Transparent noise protection cover with CE safety clearance of the knife speed when opening and returning to the previous speed when closing.
- **Excellent professional results with meat, vegetables, vegan/ vegetarian food, fish, special dough.**





Stainless steel frame

- **Very robust construction**, heavy machine, \pm 900 kg.
- **Completely stainless: entire frame, external and internal**, in AISI304 stainless steel, as well as all possible hardware and components.
- **Low height of the bowl, for a more comfortable use.**
- Adjustable, stainless steel machine feet, non-slip and vibration absorbing.
- Very solid, 90 kg cast stainless steel bowl, **with outer rim to prevent liquids or dough from spilling.**



Standard equipment

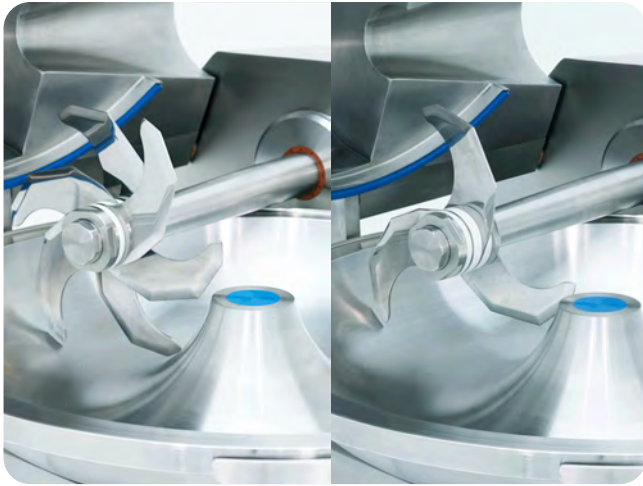

Removable 6-knife head and compensating rings for use with 3.



Control panel with large 15" Schneider Electric digital touch screen, all information displayed simultaneously and in large size.



Motorized stainless-steel knife lid for effortless lifting and lowering.

Easy cleaning



Removable lid/bowl friction band.

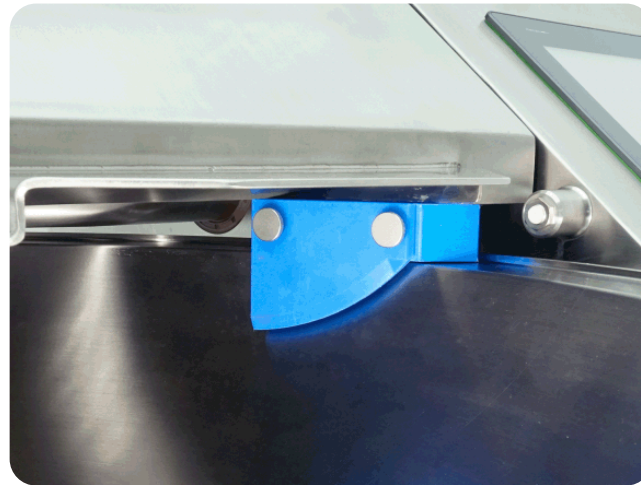

Removable bowl rim scraper.

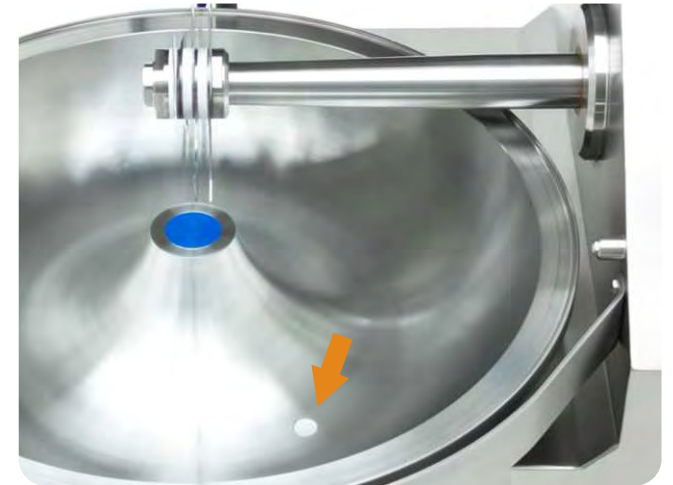

Bowl with drain plug for liquids.

Electrics and electronics

- **Powerful motors** to quickly processing of the most compact frozen dough.
- **Two knife-motor powers available.**
- **Soft start and stop of knives** and bowl by mean of speed drives.
- **High energy efficiency class IE3**, high performance ABB motors and last generation drives.
- Automatic knife safety stop.
- Thermal motor protections.
- **Fast and sensitive digital thermometer**, with sensor extended into the internal cavity of the lid.
- Folding internal electric panel, easy access, **temperature-controlled cooling system.**
- Electronic/electric components of first brands Schneider Electric and ABB.

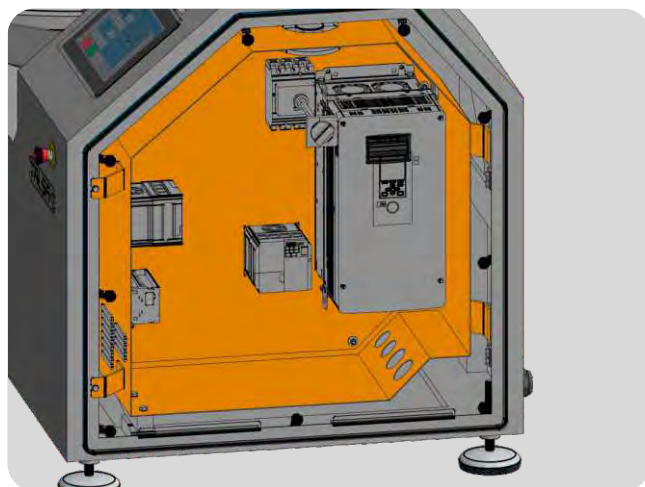

Folding internal electric panel, easy access, **temperature-controlled cooling system.**



Fast and sensitive digital thermometer, with sensor extended into the internal cavity of the lid.



Soft start and stop of knives and bowl by mean of speed drives.



Software and external connections

- Control panel with **large 15" Schneider Electric digital touch screen**, all information displayed simultaneously and in large size.
- **Extensive information** on controls, alarms, errors, diagnostics.
- Very advanced and practical software **with numerous automatic stop options**. Intuitive, easy to use.
- **Interactive recipes**, can be stored and executed directly on the machine's screen.
- New **Talsa EcoCut Power Control** to determine the machine power required to achieve the desired cutting results at any time of the process.
- **Industry 4.0 digital solutions** for maintenance, process integration and custom solutions.
- **Remote Service and Support access** over secure internet connection. (router/ethernet or mobile phone)

NEW: 15" Digital Touch Display & TalsaControl 4.0



Recipe function allows standardization of recurring processes. Standard in TalsaControl 4.0

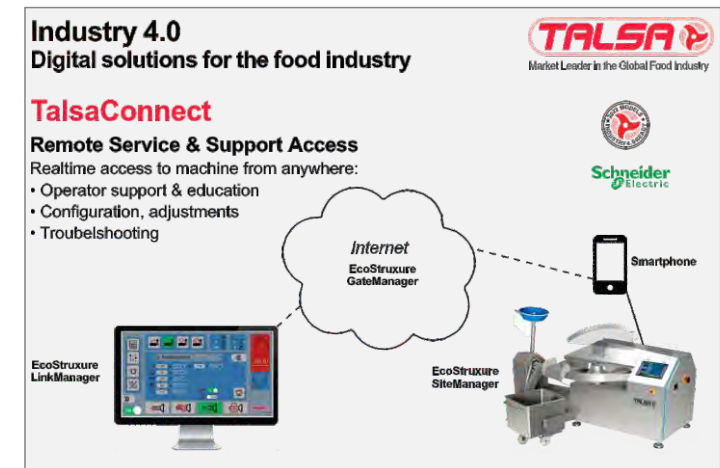

Technical specifications



K55s *Suprem*

Bowl capacity	55 liters (15 Gallon)	
Recommended batch size (approx.)	soft mix	±7 - 40 kg (±11-88 lbs)
	tough mix	±7 - 30 kg (± 11-66 lbs)
Total machine power	K55sb standard	16.5 kW / 22.5 HP
	K55spp PowerPlus	23.5 kW / 32 HP
Knife motor power	standard	15 kW / 20.5 HP
	PowerPlus	22 kW / 30 HP
Max. consumption	380/400 V	32 A
	Standard 460/480 V	27 A
	220/230 V	53 A
Max. consumption	380/400 V	42 A
	PowerPlus 460/480 V	37 A
Knife speed cutting	variable	500 - 5,000 rpm
Bowl speed cutting	variable	4 - 20 rpm
Knife speed mixing	variable	50 - 500 rpm
Bowl speed mixing	variable	4 - 20 rpm
Net weight	± 900 kg (±1,990 lbs)	

Packaging

Dimensions (wooden crate)	168x144x144 cm (66"x57"x57")
Volume	3.5 m ³
Gross weight incl. wooden crate	± 1,000 kg (±2,200 lbs)

K55s Dimensions

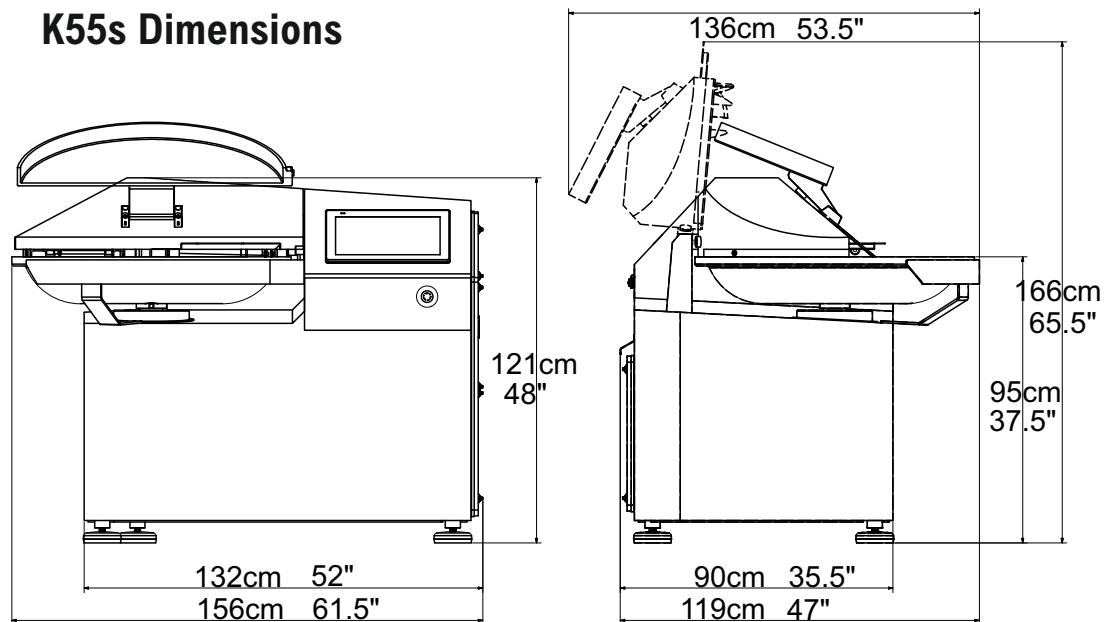

K55sb
15kW/20.5HP



K55spp
22kW/30HP

Optional:
PowerPlus - stronger knife motor for heavy applications.



Important advice: always choose large bowl cutter capacity and power, to allow the future growth of production. Available Talsa capacities: 15, 30, 55, 95, 135 and 200 liters.

TALSA, Tradition and Innovation:

40 years producing cutters.

120 years of industrial experience in machinery.

Sales and distributors in more than 60 countries.



Four generations of the Belloch family have succeeded in making what began as a small mechanical workshop founded in 1900 to serve the electrical industry, more than 100 years later an efficient industrial structure of 6000m² where attention, illusion and constant improvement is paid to every detail of our machines.

In this catalog we offer you the best of our knowledge and experience and the most modern and innovative machines, newly designed with advanced 3D software technology and R&D support from the European Union.

Thank you for your confidence.



Our product range:

- Cutters/Choppers
- Miners/Grinders
- Fillers/Stuffers
- Mixers
- Cookers/Kettles

Talsabell s.a.
Valencia - Spain
www.talsanet.com



Your authorized TALSA dealer:

Dimensions and illustrations are not binding. We reserve the right to make changes.